



NevoSwitch equipped with 9 QUAD inputs and 16 outputs

When quality matters

Quad-compatible multiswitch equipped with 9 inputs (one terrestrial and 8 for two satellites, each with its four polarities) and 16 user outputs.

Can be used as a terminal (star topology) or as a cascade by using a simple switch.

Ref.	714213
EAN13	8424450187487

Other features

Power Supply	12V - 1.5A (UK plug)
---------------------	----------------------

Packaging info

Box	1 pcs.
------------	--------

Highlights

- 10 dB Low Gain (LG) / High Gain (HG) switch for the attenuation of the satellite input signal for each 8-user group
- Optimized for Quad LNB thanks to a 22 KHz generator
- Compatible with return-channel applications
- European design, quality, and manufacturing

Main features

- Very compact
- Made of zamak
- Input and output colour identification
- Available ECO mode
- Selector switch to shift between cascade and terminal modes
- 12 V power supply
- Low power consumption

Application example

SIMPLE CONFIGURATION

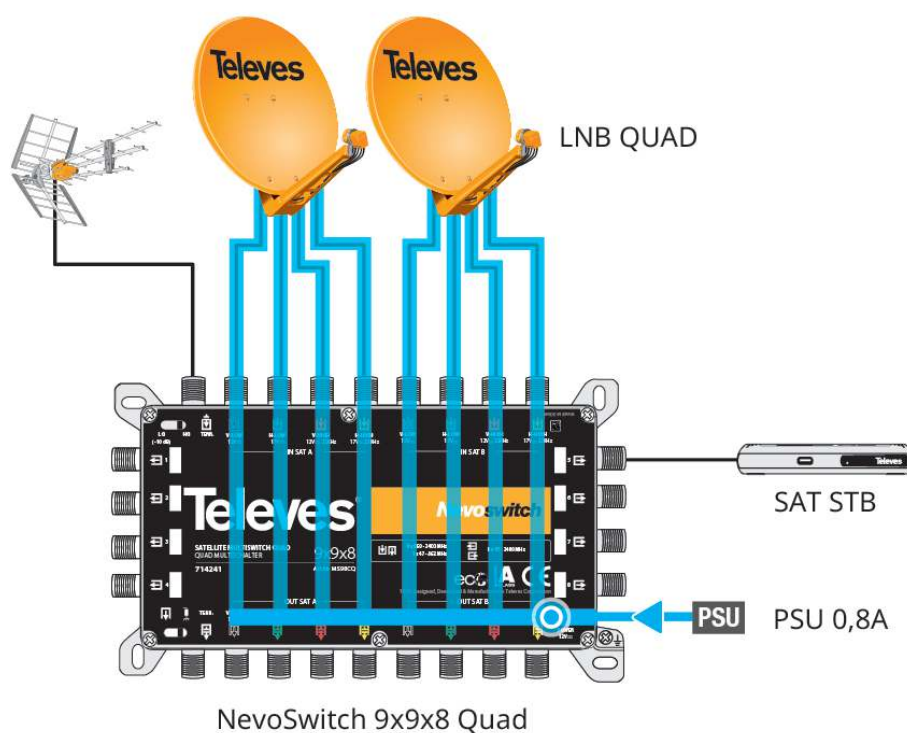

Technical specifications : Ref. 714213

Number of inputs		9
Number of cascable outputs		9
Number of user outputs		16
Frequency range TERR.	MHz	88 ... 862
Frequency range SAT.	MHz	950 ... 2400
Input level TERR.	dBµV	90
Input level SAT.	dBµV	112
Through losses TERR.	dB	4
Through losses SAT.	dB	3.5 ... 10
Tap losses 1...8 TERR.	dB	4
Tap losses 1...8 SAT.	dB	0
Tap losses 9...16 TERR.	dB	6
Tap losses 9...16 SAT.	dB	4
Isolation H/V	dB	> 30
Isolation users	dB	> 25
Powering	Vdc	12
Max. current (PSU - LG)	mA	155
Max. current (PSU - HG)	mA	215
Max. current (STB)	mA	35
Operating temperature	°C	-5 ... 45
Protection index		20