



NevoSwitch equipped with 9 QUAD inputs and 12 outputs

When quality matters

Quad-compatible multiswitch equipped with 9 inputs (one terrestrial and 8 for two satellites, each with its four polarities) and 12 user outputs.

Can be used as a terminal (star topology) or as a cascade by using a simple switch.

Ref.	714242
Logical ref.	MS912CQ
EAN13	8424450190159

Other features

Power Supply	PSU not included
---------------------	------------------

Packaging info

Box	1 pcs.
------------	--------

Physical data

Net weight	1,140.00 g
Gross weight	1,241.00 g
Width	208.00 mm
Height	253.00 mm
Depth	30.00 mm

Highlights

- 10 dB Low Gain (LG) / High Gain (HG) switch for the attenuation of the satellite input signal for each 8-user group
- Optimized for Quad LNB thanks to a 22 KHz generator
- Compatible with return-channel applications

- European design, quality, and manufacturing

Main features

- Very compact
- Made of zamak
- Input and output colour identification
- Available ECO mode
- Selector switch to shift between cascade and terminal modes
- 12 V power supply
- Low power consumption

Application example

SIMPLE CONFIGURATION

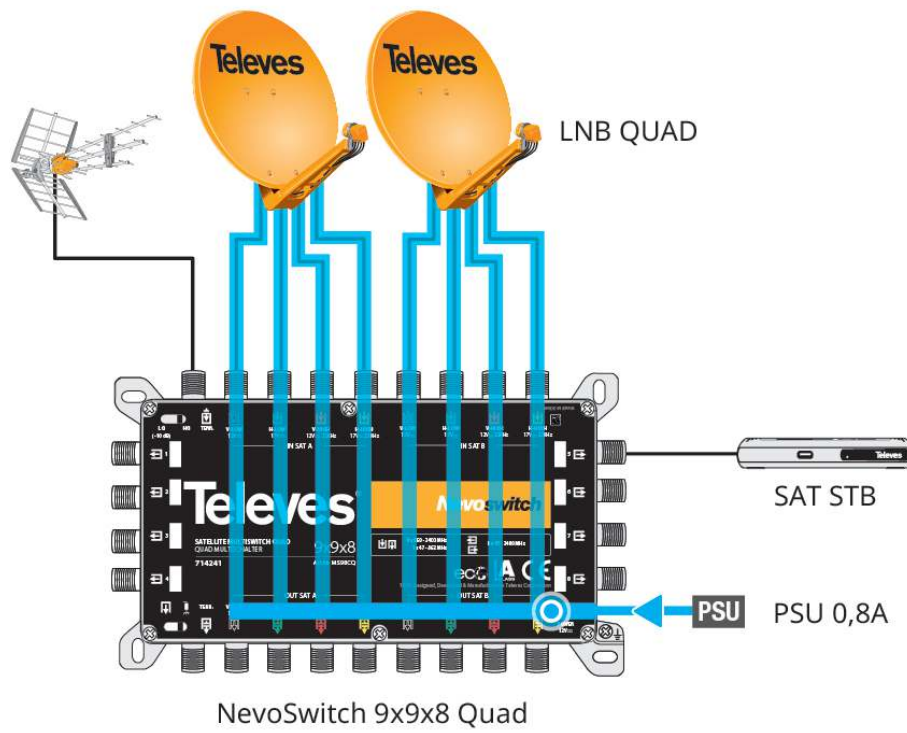

Technical specifications : Ref. 714242

Number of inputs		9
Number of cascable outputs		9
Number of user outputs		12
Frequency range TERR.	MHz	88 ... 862
Frequency range SAT.	MHz	950 ... 2400
Input level TERR.	dBμV	90
Input level SAT.	dBμV	112
Through losses TERR.	dB	4
Through losses SAT.	dB	3.5 ... 10
Tap losses 1...8 TERR.	dB	4
Tap losses 1...8 SAT.	dB	0
Tap losses 9...16 TERR.	dB	6
Tap losses 9...16 SAT.	dB	4
Isolation H/V	dB	> 30
Isolation users	dB	> 25
Powering	Vdc	12
Max. current (PSU - LG)	mA	135
Max. current (PSU - HG)	mA	195
Max. current (STB)	mA	35
Operating temperature	°C	-5 ... 45
Protection index		20